



PI84 with socket GZM80 interface relays

RM84 + GZM80



- Interface relay **PI84 with socket GZM80** consists of: electromagnetic relay **RM84**, grey plug-in socket **GZM80**, signalling / protecting module: version **LD** - M41G or M43G (L - LED green, D - diode, polarization N: +A1/-A2); version **LV** - M91G or M93G (L - LED green, V - varistor), retainer / retractor clip **GZT80-0040** (plastic), white description plate **GZT80-0035**
- 35 mm rail mount acc. to PN-EN 60715 or on panel mounting with one M3 screw
- May be linked with interconnection strip type **ZGGZ80**
- Recognitions, certifications, directives: recognitions RM84, RoHS,  

Contact data

Number and type of contacts		2 CO
Contact material		AgNi
Rated / max. switching voltage	AC	250 V / 440 V
Min. switching voltage		5 V
Rated load (capacity)	AC1	8 A / 250 V AC
	AC15	3 A / 120 V 1,5 A / 240 V (B300)
	AC3	550 W (single-phase motor)
	DC1	8 A / 24 V DC (see Fig. 3)
	DC13	0,22 A / 120 V 0,1 A / 250 V (R300)
Min. switching current		5 mA
Max. inrush current		15 A
Rated current		8 A
Max. breaking capacity	AC1	2 000 VA
Min. breaking capacity		0,3 W
Contact resistance		≤ 100 mΩ
Max. operating frequency		
• at rated load	AC1	600 cycles/hour
• no load		72 000 cycles/hour
Coil data		
Rated voltage	50/60 Hz AC	12 ... 230 V
	DC	12 ... 110 V
Must release voltage		AC: ≥ 0,15 U _n DC: ≥ 0,1 U _n
Operating range of supply voltage		see Tables 1, 2 and Fig. 4, 5
Rated power consumption	AC	0,75 VA
	DC	0,4 ... 0,48 W
Insulation according to PN-EN 60664-1		
Insulation rated voltage		300 V AC
Rated surge voltage		4 000 V 1,2 / 50 μs
Overvoltage category		III
Insulation pollution degree		3
Dielectric strength		
• between coil and contacts		5 000 V AC type of insulation: reinforced
• contact clearance		1 000 V AC type of clearance: micro-disconnection
• pole - pole		2 500 V AC type of insulation: basic
Contact - coil distance		
• clearance		≥ 10 mm
• creepage		≥ 10 mm
General data		
Operating / release time (typical values)		7 ms / 3 ms
Electrical life		
• resistive AC1		> 10 ⁵ 8 A, 250 V AC
• cosφ		see Fig. 2
• cosφ = 0,4		> 10 ⁵ 3 A, 250 V AC
• DC L/R=40 ms		> 10 ⁵ 0,12 A, 220 V DC
Mechanical life (cycles)		> 3 x 10 ⁷
Dimensions (L x W x H)		78,1 x 15,9 x 66,5 mm
Weight		59 g
Ambient temperature	• storage	-40...+85 °C
	• operating	AC: -40...+70 °C DC: -40...+85 °C
Cover protection category		IP 20 PN-EN 60529
Environmental protection		RM84: RTII GZM80: RT0 PN-EN 116000-3
Shock resistance		20 g
Vibration resistance	(NO/NC)	10 g / 5 g 10...150 Hz

The data in bold type pertain to the standard versions of the relays.

Coil data - DC voltage version

Table 1

Coil code	Rated voltage V DC	Coil resistance at 20 °C Ω	Acceptable resistance	Coil operating range V DC	
				min. (at 20 °C)	max. (at 20 °C)
012DC	12	360	± 10%	8,4	30,6
024DC	24	1 440	± 10%	16,8	61,2
110DC	110	25 200	± 10%	77,0	280,0

The data in bold type pertain to the standard versions of the relays.

Coil data - AC 50/60 Hz voltage version

Table 2

Coil code	Rated voltage V AC	Coil resistance at 20 °C Ω	Acceptable resistance	Coil operating range V AC 50 Hz	
				min. (at 20 °C)	max. (at 20 °C)
012AC	12	100	± 10%	9,6	13,2
024AC	24	400	± 10%	19,2	26,4
120AC	120	10 200	± 10%	96,0	144,0
230AC	230	38 500	± 10%	184,0	253,0

The data in bold type pertain to the standard versions of the relays.

Dimensions

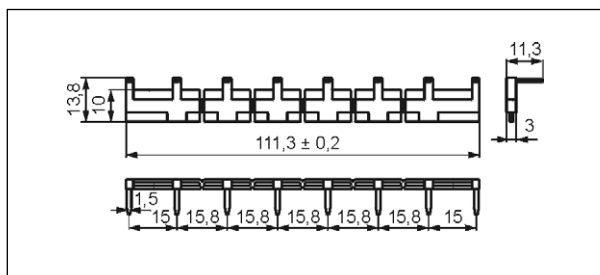
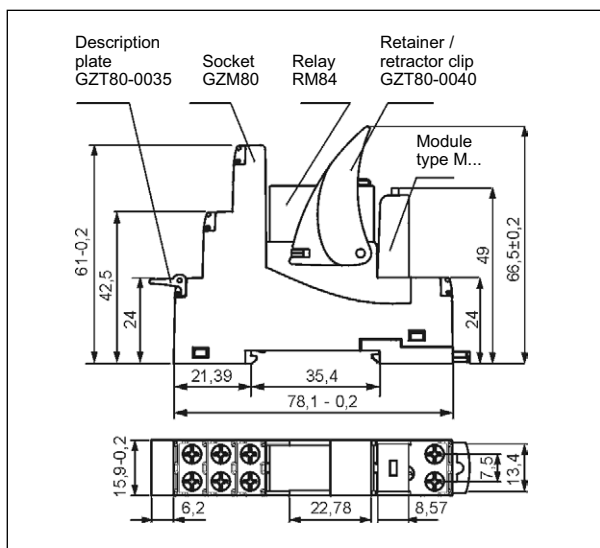

Interconnection strip type **ZGGZ80**

Connection diagrams

(screw terminals side view)

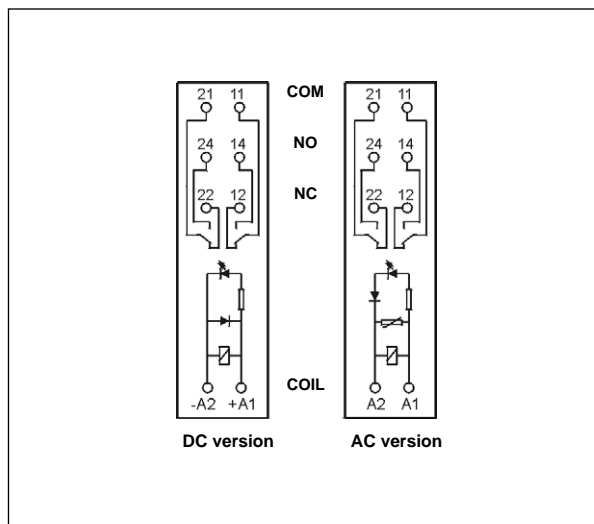

Connection of GZM80

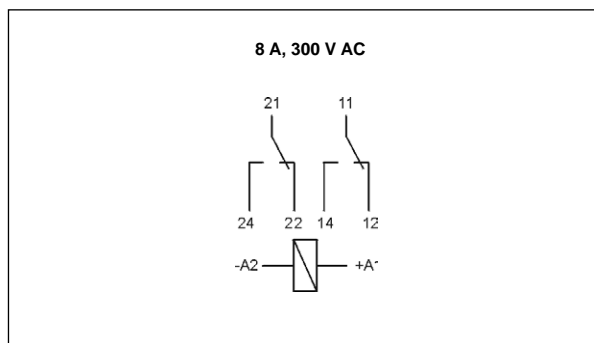

Electrical life at AC resistive load.
Switching frequency: 600 cycles/hour

Fig. 1

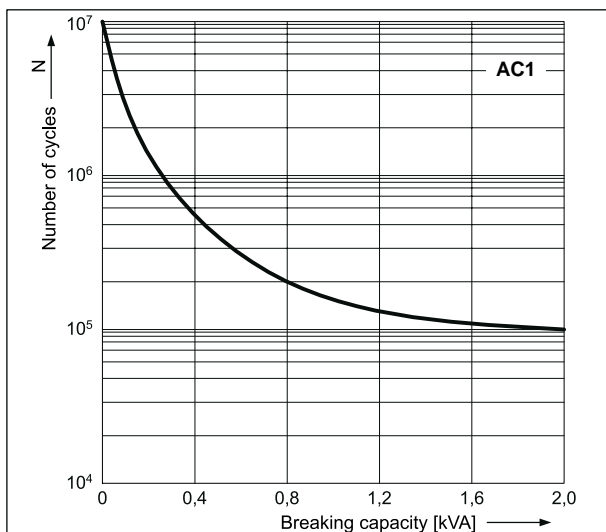

Electrical life reduction factor at AC inductive load

Fig. 2

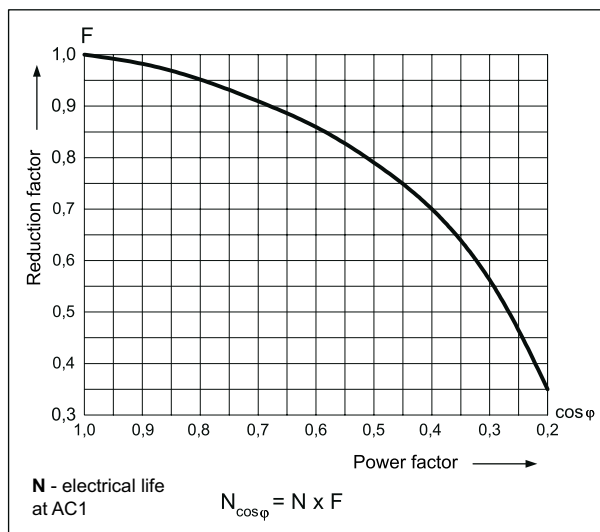

Max. DC resistive load breaking capacity

Fig. 3

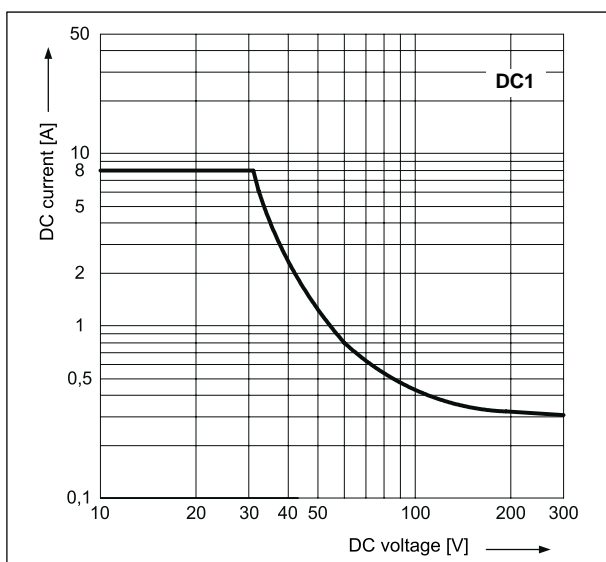

Coil operating range - DC

Fig. 4

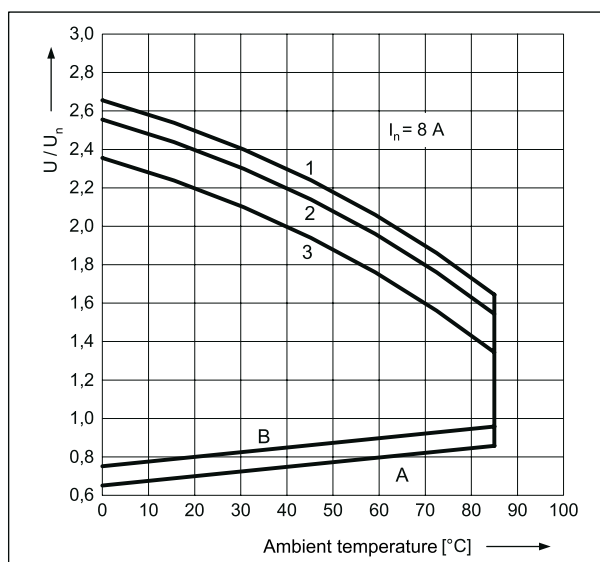

Coil operating range - AC 50 Hz

Fig. 5

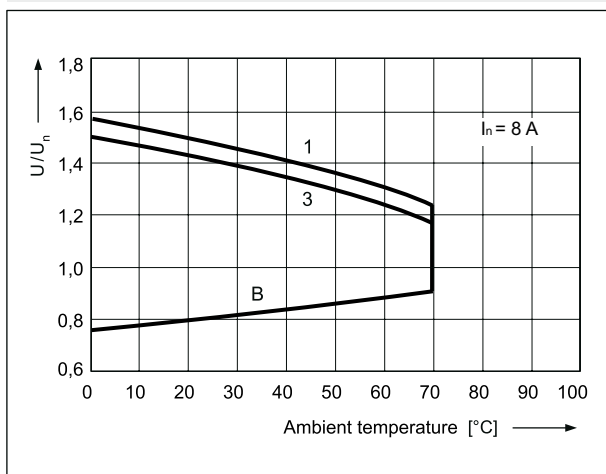

Description of Fig. 4 and 5

A - relations between make voltage and ambient temperature at no load on contacts. Coil temperature and ambient temperature are equal before coil energizing. Make voltage is not higher than the value read on Y axis (multiplication of rated voltage).

B - relations between make voltage and ambient temperature after initial coil heating up with 1,1 U_n , at continues load of I_n on contacts. Make voltage is not higher than the value read on Y axis (multiplication of rated voltage).

1, 2, 3 - values on Y axis represent allowed overvoltage on coil at certain ambient temperature and contact load:

- 1 - no load
- 2 - 50% of rated load
- 3 - rated load

