





RM85 105 °C sensitive miniature relays



- For PCB and plug-in sockets
- Accessories: sockets and modules
- DC coils - sensitive
- Ambient temperature up to 105 °C
- Applications: in household equipment, in temperature controllers
- Compliance with standard PN-EN 60335-1
- Recognitions, certifications, directives: RoHS,     

Contact data

Number and type of contacts	1 NO	
Contact material	AgNi, AgNi/Au 5 µm, AgSnO₂	
Rated / max. switching voltage	AC	250 V / 440 V
Min. switching voltage	5 V AgNi, 5 V AgNi/Au 5 µm, 10 V AgSnO ₂	
Rated load (capacity)	AC1	16 A / 250 V AC
	AC15	3 A / 120 V 1,5 A / 240 V (B300)
	AC3	750 W (single-phase motor)
	DC1	16 A / 24 V DC (see Fig. 2)
	DC13	0,22 A / 120 V 0,1 A / 250 V (R300)
Min. switching current	5 mA AgNi, 2 mA AgNi/Au 5 µm, 10 mA AgSnO ₂	
Max. inrush current	30 A AgSnO ₂	
Rated current	16 A	
Max. breaking capacity	AC1	4 000 VA
Min. breaking capacity	0,3 W AgNi, 0,05 W AgNi/Au 5 µm, 1 W AgSnO ₂	
Contact resistance	≤ 100 mΩ	
Max. operating frequency	AC1	• at rated load • no load
		600 cycles/hour 72 000 cycles/hour
Coil data		
Rated voltage	DC	5 ... 48 V
Must release voltage	DC: ≥ 0,1 U _n	
Operating range of supply voltage	see Table 1 and Fig. 3	
Rated power consumption	DC	0,25 W
Insulation according to PN-EN 60664-1		
Insulation rated voltage	400 V AC	
Rated surge voltage	4 000 V 1,2 / 50 µs	
Overvoltage category	III	
Insulation pollution degree	3	
Dielectric strength	• between coil and contacts	5 000 V AC type of insulation: reinforced
	• contact clearance	1 000 V AC type of clearance: micro-disconnection
Contact - coil distance	• clearance	≥ 10 mm
	• creepage	≥ 10 mm
General data		
Operating / release time (typical values)	8 ms / 3 ms	
Electrical life (number of cycles)	• resistive AC1	> 10 ⁵ 16 A, 230 V AC, 70 °C
		> 2 x 10 ⁴ 16 A, 230 V AC, 105 °C
		> 1,7 x 10 ⁵ 10 A, 230 V AC, 105 °C
		> 2,8 x 10 ⁵ 8 A, 230 V AC, 105 °C
		> 3,2 x 10 ⁵ 6 A, 230 V AC, 105 °C
	• cosφ • DC L/R=40 ms	see Fig. 1 > 10 ⁵ 0,15 A, 220 V DC
Mechanical life (cycles)	> 3 x 10 ⁷	
Dimensions (L x W x H)	29 x 12,7 x 15,7 mm	
Weight	14 g	
Ambient temperature	• storage	-40...+105 °C
	• operating	-40...+105 °C
Cover protection category	IP 40	PN-EN 60529
Environmental protection	RTII	PN-EN 116000-3
Shock resistance	30 g	
Vibration resistance	10 g 10...150 Hz	
Solder bath temperature	max. 270 °C	
Soldering time	max. 5 s	

The data in bold type pertain to the standard versions of the relays.

RM85 105 °C sensitive miniature relays

Coil data - DC voltage version, sensitive version

Table 1

Coil code	Rated voltage V DC	Coil resistance at 20 °C Ω	Acceptable resistance	Coil operating range V DC	
				min. (at 20 °C)	max. (at 20 °C)
S005	5	102	$\pm 10\%$	3,75	15,0
S006	6	144	$\pm 10\%$	4,50	18,0
S009	9	330	$\pm 10\%$	6,75	27,0
S010	10	380	$\pm 10\%$	7,50	30,0
S012	12	580	$\pm 10\%$	9,00	36,0
S018	18	1 300	$\pm 10\%$	13,50	54,0
S024	24	2 300	$\pm 10\%$	18,00	72,0
S048	48	9 340	$\pm 10\%$	36,00	144,0

Dimensions

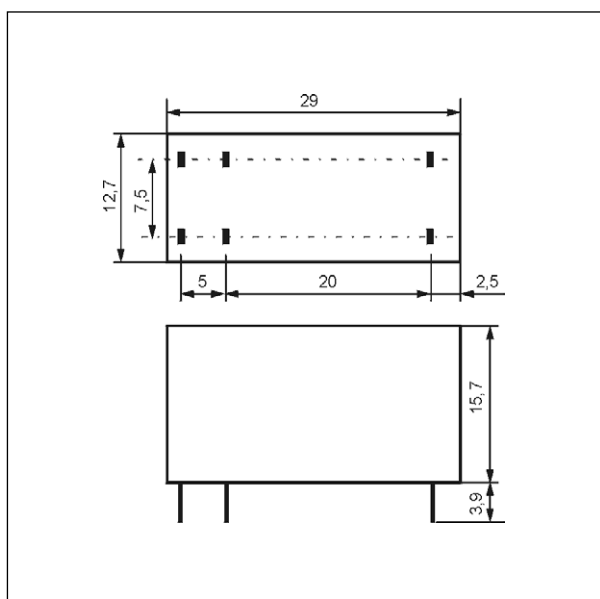

Connection diagram (pin side view)

1 NO

Terminal (pin)	A1(1); A2(2)	21(4); 24(5); 11(7); 14(8)
[mm]	$\varnothing 0,6$	$0,5 \times 0,9$

Drilling hole:
 • for relays $\varnothing 1,3 + 0,1$ mm
 • for sockets $\varnothing 1,5 + 0,1$ mm

RM85 105 °C sensitive terminals are doubled for each contact. Both terminals are to be used while connecting to load.

Pinout (solder side view)

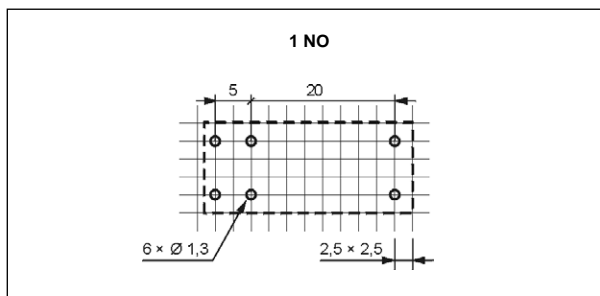

Connection of GZ... sockets

Note: Loads above 12 A (GZT80, GZM80) or 10 A (GZS80, GZMB80) require bridging pairs of terminals: 11 with 21, 12 with 22, 14 with 24. Loads up to 12 A or 10 A do not require bridging of common terminals (such bridges may be fixed, however).

Electrical life reduction factor at AC inductive load

Fig. 1

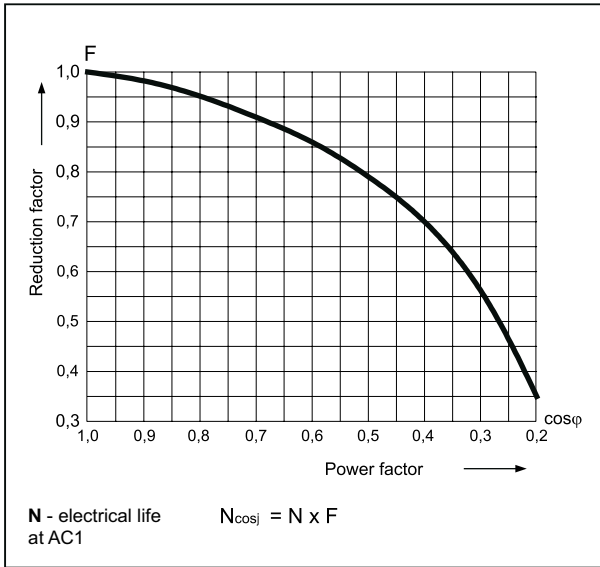

Max. DC resistive load breaking capacity

Fig. 2

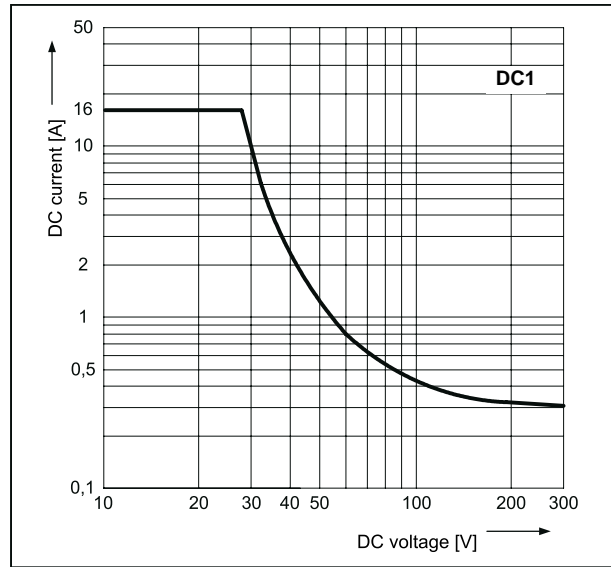

Coil operating range - DC

Fig. 3

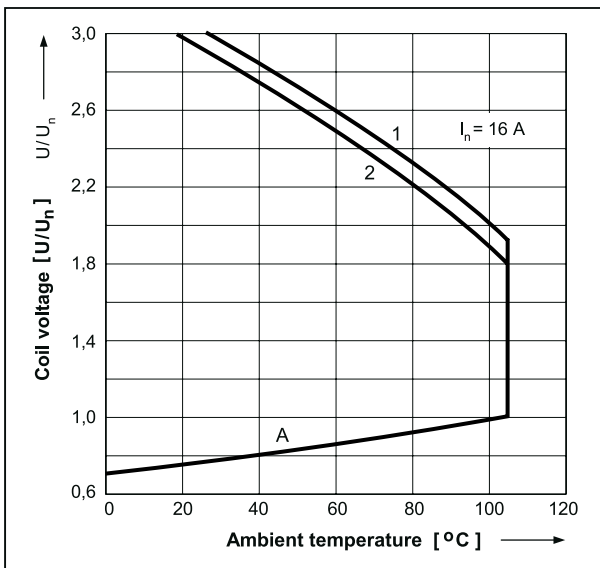

Description of Fig. 3

A - relations between make voltage and ambient temperature at no load on contacts. Coil temperature and ambient temperature are equal before coil energizing. Make voltage is not higher than the value read on Y axis (multiplication of rated voltage).

1, 2 - values on Y axis represent allowed overvoltage on coil at certain ambient temperature and contact load:

- 1** - no load
- 2** - rated load

RM85 105 °C sensitive miniature relays

Mounting

Relays **RM85 105 °C sensitive** are designed for: • direct PCB mounting • screw terminals plug-in sockets **GZT80** ① ② and **GZM80** ① ② with clip **GZT80-0040** or **GZM80-0041**; plug-in sockets **GZS80** ① ② with clip **GZS-0040** or **GZM80-0041**, 35 mm rail mount acc. to PN-EN 60715 or on panel mounting with one M3 screw • spring terminals plug-in sockets **GZMB80** ① ② with clip **GZMB80-0040** or **GZM80-0041**, 35 mm rail mount acc. to PN-EN 60715. Signalling / protecting modules **type M...** are available with sockets (see page 8) • plug-in sockets for PCB mounting **EC 50** with clip **MP16-2**, MH16-2; plug-in sockets **PW80** with clip **MH16-2**; plug-in sockets **GD50** with clip **MP16-2**, GD-0016, MH16-2.

① Loads above 12 A (GZT80, GZM80) or 10 A (GZS80, GZMB80) require bridging pairs of terminals: 11 with 21, 12 with 22, 14 with 24 - see page 2.

② Plug-in sockets **GZT80**, **GZM80**, **GZS80** may be linked with interconnection strip type **ZGGZ80** (see page 9).

③ For sockets **GZMB80** - see page 6 (wire connection).

Ordering codes

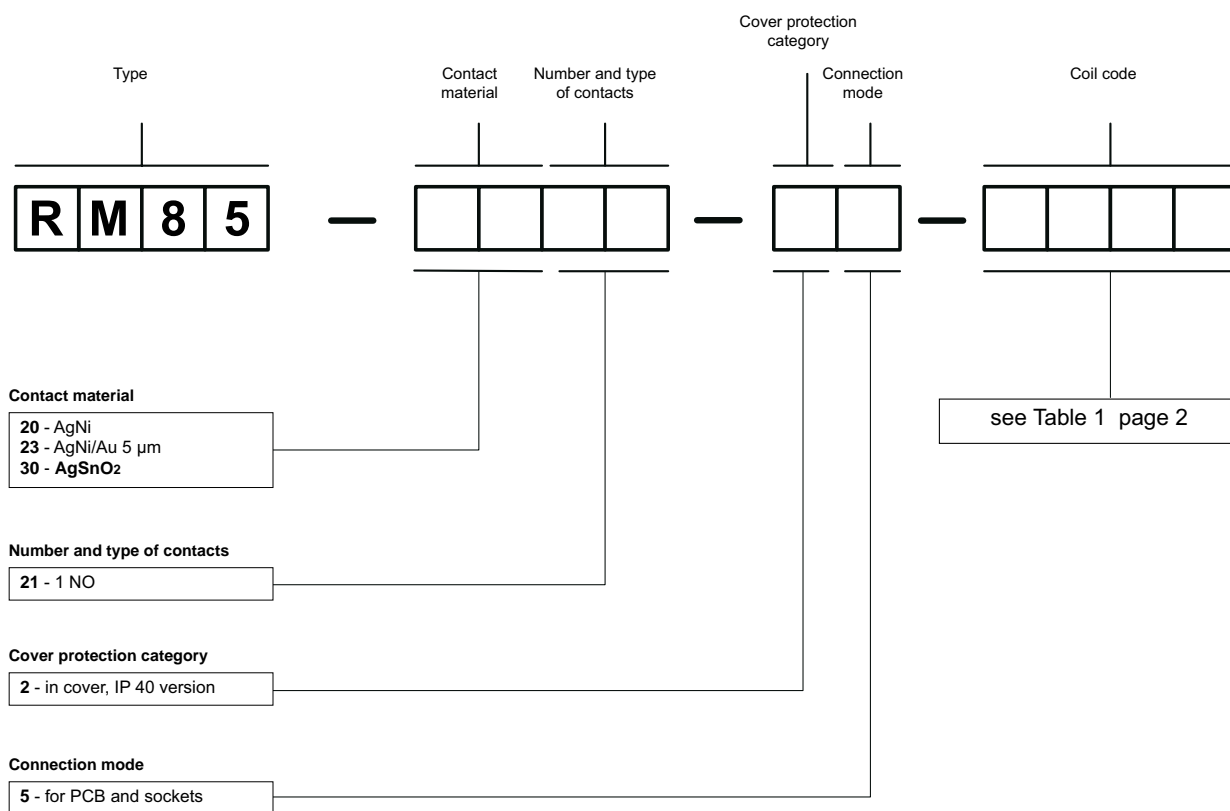

Examples of ordering code:

RM85-3021-25-S012

relay **RM85 105 °C sensitive**, for PCB and sockets, one normally open contact, contact material AgSnO₂, sensitive coil voltage 12 V DC, in cover IP 40

RM85-2321-25-S005

relay **RM85 105 °C sensitive**, for PCB and sockets, one normally open contact, contact material AgNi/Au 5 µm, sensitive coil voltage 5 V DC, in cover IP 40

Plug-in sockets and accessories

GZT80

For RM84, RM85, RM85 inrush, RM85 105 °C sensitive, RMB841, RMB851, RM87L, RM87L sensitive, RM87P, RM87P sensitive

Screw terminals
Max. tightening moment for the terminal: 0,7 Nm
35 mm rail mount
acc. to PN-EN 60715
or on panel mounting
75,3 x 15,5 x 61(67) mm
Two poles, 5 mm pinout
12 A, 300 V AC



Connection diagrams ⑧

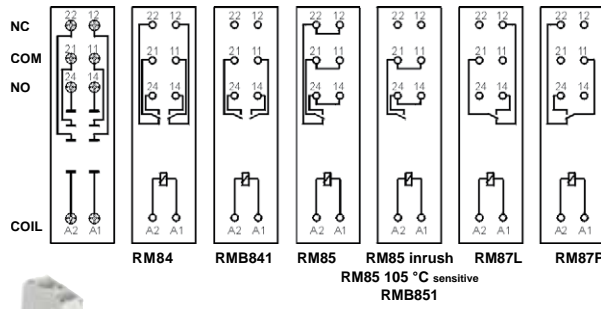

Accessories ① ZGGZ80 GZM80-0041

Dimensions

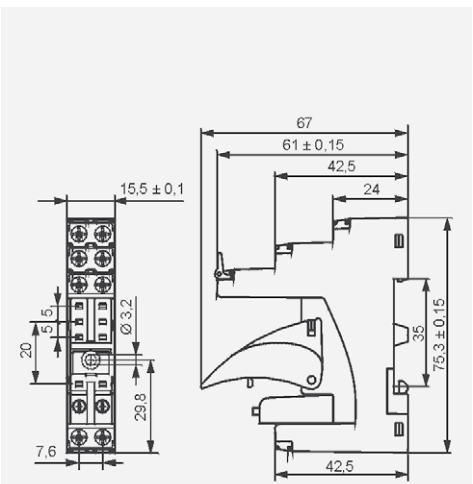

GZM80

For RM84, RM85, RM85 inrush, RM85 105 °C sensitive, RMB841, RMB851, RM87L, RM87L sensitive, RM87P, RM87P sensitive

Screw terminals
Max. tightening moment for the terminal: 0,7 Nm
35 mm rail mount
acc. to PN-EN 60715
or on panel mounting
78,1 x 15,9 x 61(66,5) mm
Two poles, 5 mm pinout
12 A, 300 V AC



Connection diagrams ⑧

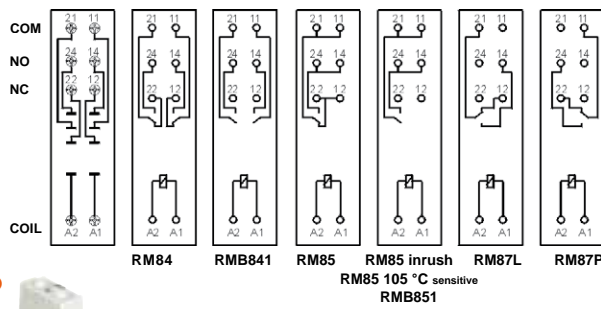

Accessories ① ZGGZ80 GZM80-0041

Dimensions

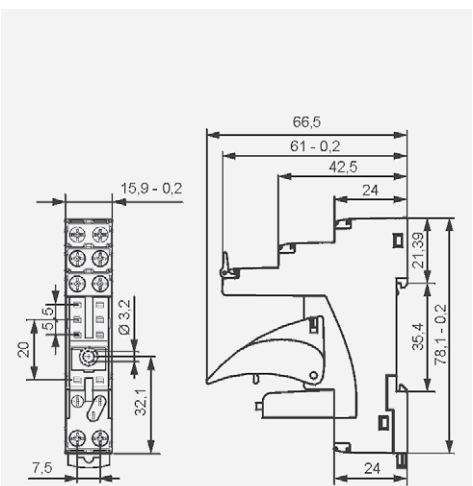

GZS80

For RM84, RM85, RM85 inrush, RM85 105 °C sensitive, RMB841, RMB851, RM87L, RM87L sensitive, RM87P, RM87P sensitive

Screw terminals
Max. tightening moment for the terminal: 0,5 Nm
35 mm rail mount
acc. to PN-EN 60715
or on panel mounting
76,8 x 15,8 x 42,5(57,1) mm
Two poles, 5 mm pinout
10 A, 300 V AC



Connection diagrams ⑧

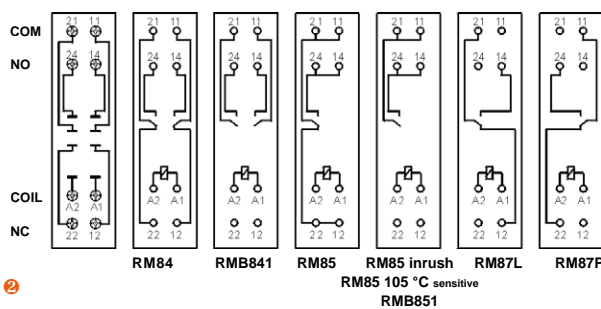

Accessories ① ZGGZ80 GZM80-0041

Dimensions

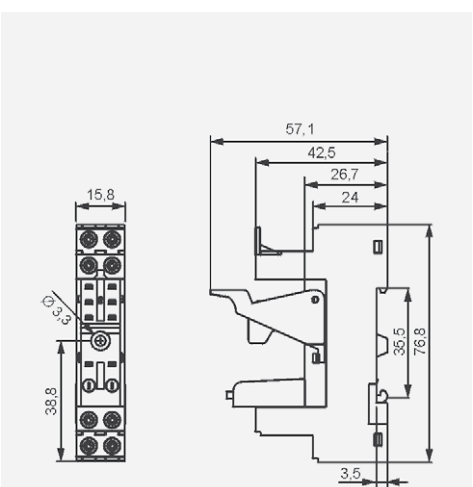

① Mounting and sub-assemblies of accessories in the socket - see page 7. Signalling / protecting modules type M... - see page 8. ② In the bracket the height of socket with retainer / retractor clip is shown. ③ For RM85, RM85 inrush, RM85 105 °C sensitive, RMB851: loads above 12 A (GZT80, GZM80) or 10 A (GZS80, GZM80) require bridging pairs of terminals: 11 with 21, 12 with 22, 14 with 24 - see page 2; For RMB841, RMB851 - see www.repol.com.pl (energizing of bistable relays)

Plug-in sockets and accessories

GZMB80

For RM84, RM85, RM85 inrush, RM85 105 °C sensitive, RMB841, RMB851, RM87L, RM87L sensitive, RM87P, RM87P sensitive

Spring terminals
Max. cross section of the cables:
1 x 0,2...1,5 mm²
(1 x 24...16 AWG)
Length of the cable deinsulation: 9...11 mm

35 mm rail mount
acc. to PN-EN 60715
97 x 16 x 45,2(69) mm
Two poles, 5 mm pinout
10 A, 300 V AC



GZMB80-0040



TR



Module type M...



GZM80-0041

Connection diagrams ⑥

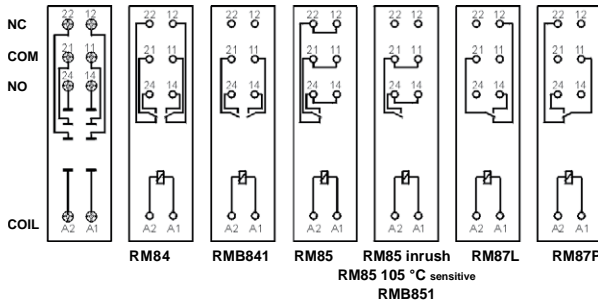

Dimensions

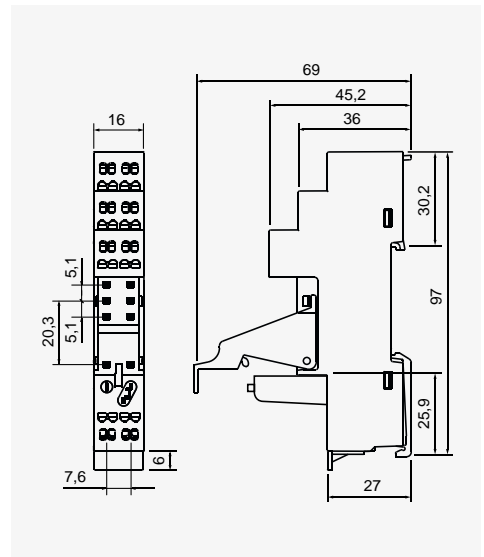

The drawings present the sequence of operations in course of inserting wires to the spring terminal, and the recommended screwdriver to be used for opening of case springs, comply with the DIN 5264 FORM „A”.

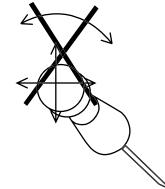
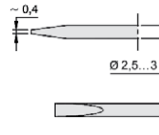
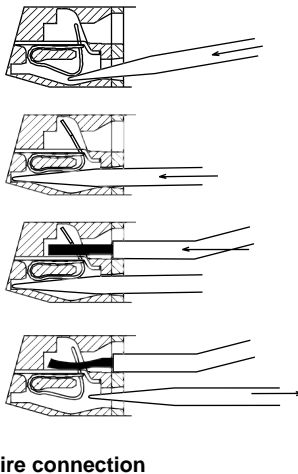

Accessories ①

Wire connection

EC 50

For RM84, RM85, RM85 inrush, RM85 105 °C sensitive, RMB841, RMB851, RM87L, RM87L sensitive, RM87P, RM87P sensitive, RM83, RM94

For PCB
31,3 x 12,7 x 9 mm
Two poles, 5 mm pinout
8 A, 300 V AC



Pinout

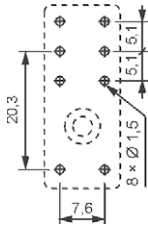

Accessories

Dimensions

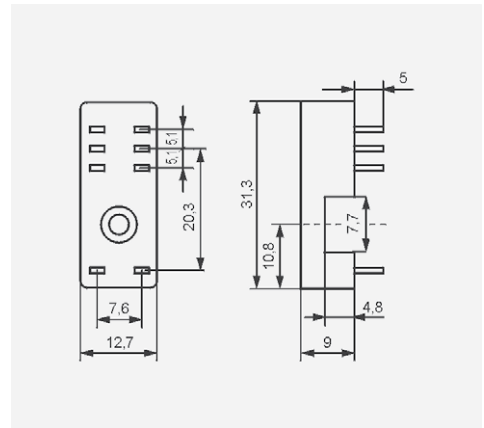

PW80

For RM84, RM85, RM85 inrush, RM85 105 °C sensitive, RMB841, RMB851, RM87L, RM87L sensitive, RM87P, RM87P sensitive, RM83, RM94

For PCB
34,6 x 12,9 x 6,6 mm
Two poles, 5 mm pinout
8 A, 250 V AC



Pinout

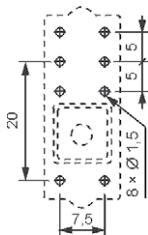

Accessories

Dimensions

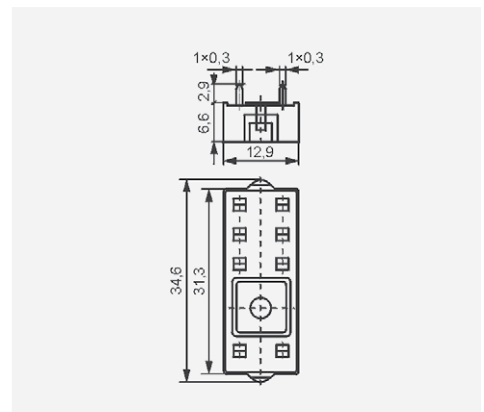

① Mounting and sub-assemblies of accessories in the socket - see page 7. Signalling / protecting modules type M... - see page 8. ② In the bracket the height of socket with retainer / retractor clip is shown. ③ For RM85, RM85 inrush, RM85 105 °C sensitive, RMB851: loads above 12 A (GZT80, GZM80) or 10 A (GZS80, GZMB80) require bridging pairs of terminals: 11 with 21, 12 with 22, 14 with 24 - see page 2; For RMB841, RMB851 - see www.repol.com.pl (energizing of bistable relays)

Plug-in sockets and accessories

GD50

For RM84, RM85, RM85 inrush, RM85 105 °C sensitive, RMB841, RMB851, RM87L, RM87L sensitive, RM87P, RM87P sensitive, RM83, RM94

For PCB
31,5 x 13 x 9 mm
Two poles, 5 mm pinout
8 A, 300 V AC



Pinout

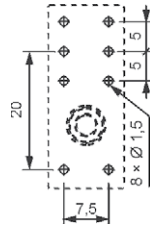

Dimensions

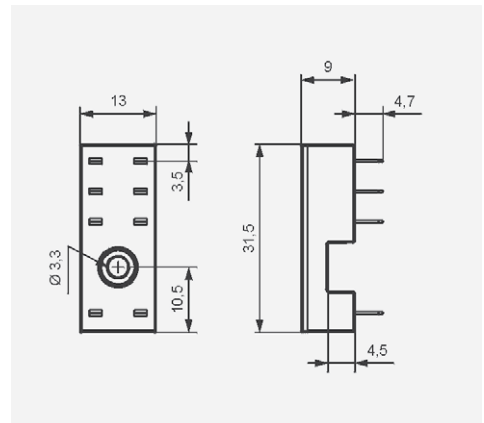

Accessories

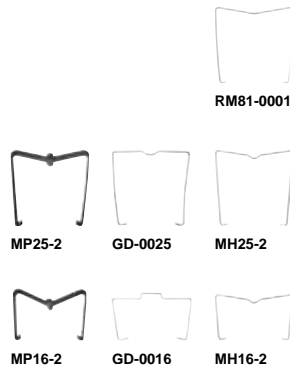

Mounting and sub-assemblies of the relay and accessories in the socket

Signalling / protecting module type M...

Electromagnetic relay

Retainer / retractor clip

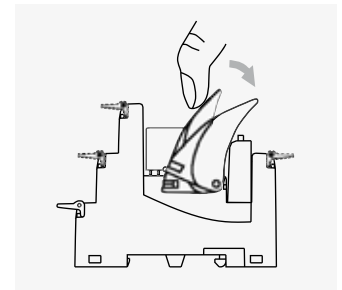

Removing the relay from the socket with a retractor / retractor clip

Screw terminals plug-in socket

Description plate

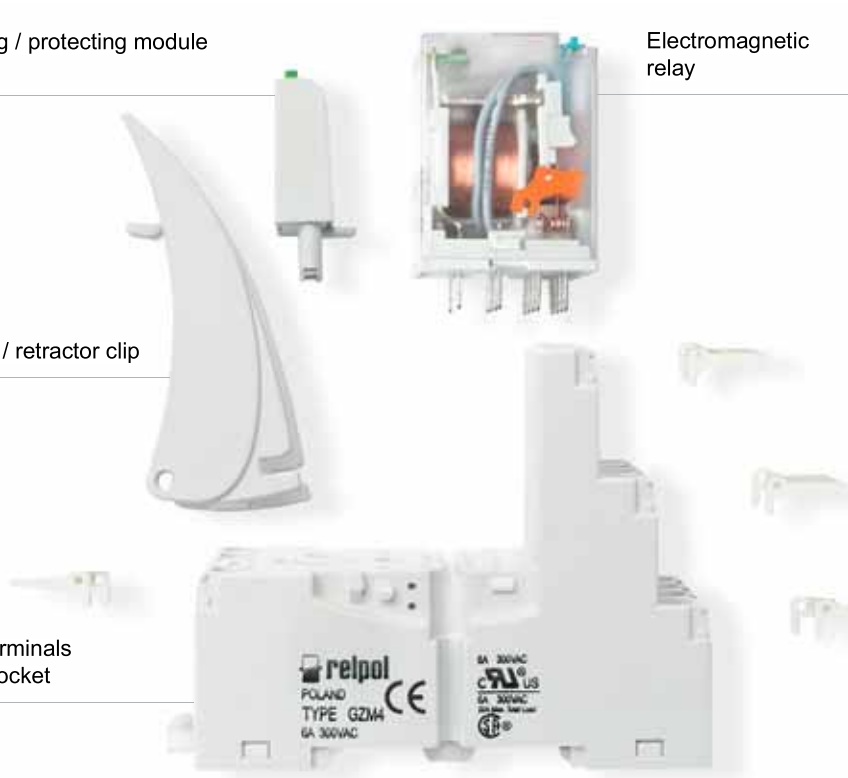

PRECAUTIONS:

1. Ensure that the parameters of the product described in its specification provide a safety margin for the appropriate operation of the device or system and never use the product in circumstances which exceed the parameters of the product. 2. Never touch any live parts of the device. 3. Ensure that the product has been connected correctly. An incorrect connection may cause malfunction, excessive heating or risk of fire. 4. In case of any risk of any serious material loss or death or injuries of humans or animals, the devices or systems shall be designed so to equip them with double safety system to guarantee their reliable operation.

Signalling / protecting modules type M...

For sockets type:

GZT80, GZM80, GZS80, GZMB80, GZT92, GZM92, GZS92, ES 32,
GZT2, GZM2, GZMB2, GZT3, GZM3, GZT4, GZM4, GZMB4

Modules type M... are parallely connected with relay coil.

Polarity P: -A1/+A2. Polarity N: +A1/-A2.



Modules type M...	Layout	Voltage	Type of module ① ②
Module D (polarization P) It limits overvoltage on DC coils.		6/230 V DC	M21P
Module D (polarization N) It limits overvoltage on DC coils.		6/230 V DC	M21N
Module LD (polarization P) It limits overvoltage on DC coils. Coil energizing indication.		6/24 V DC 24/60 V DC 110/230 V DC	M31R, M31G M32R, M32G M33R, M33G
Module LD (polarization N) It limits overvoltage on DC coils. Coil energizing indication.		6/24 V DC 24/60 V DC 110/230 V DC	M41R, M41G M42R, M42G M43R, M43G
Module RC It protects against EMC disturbance. It limits overvoltage.		6/24 V AC 24/60 V AC 110/240 V AC	M51 M52 M53
Module L Coil energizing indication.		6/24 V AC/DC 24/60 V AC/DC 110/230 V AC/DC	M61R, M61G M62R, M62G M63R, M63G
Module LV It limits overvoltage on AC and DC coils. Coil energizing indication.		6/24 V AC/DC 24/60 V AC/DC 110/230 V AC/DC	M91R, M91G M92R, M92G M93R, M93G
Module V It limits overvoltage on AC and DC coils. No indication.		24 V AC 130 V AC 230 V AC	M71 M72 M73
Module R It limits overvoltage on AC coils.		110/230 V AC	M103

① M...R - LED red, M...G - LED green

② When ordering modules indicate their color: gray or black.

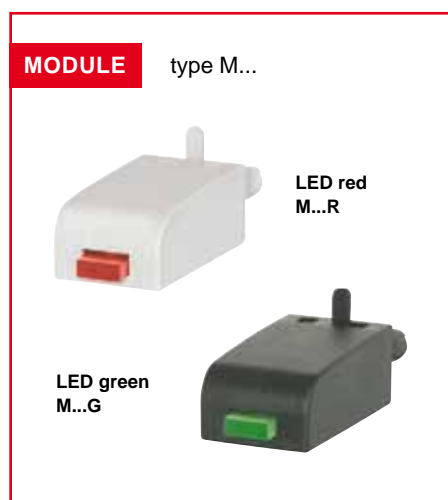

Interconnection strips ZGGZ80



ZGGZ80 for:

Plug-in sockets	Relays for plug-in sockets	Interface relays ①
GZT80	RM84, RM85, RM85 inrush, RM85 105 °C sensitive, RM87L ☺, RM87P ☺ RM87N ☺	PI84-...-M..G (GZT80 + RM84)
GZM80		PI84-...-00L. (GZM80 + RM84)
GZS80		PI85-...-M..G (GZT80 + RM85)
GZT92		PI85-...-00L. (GZM80 + RM85)
GZM92		
GZS92		
ES 32	RM96 1 CO	

① Interface relay **PI84 (PI85)** is offered as a **set**: plug-in socket **GZT80** or **GZM80** + miniature relay **RM84 (RM85)** + signalling / protecting module **type M...** + retainer / retractor clip **GZT80-0040** + description plate **GZT80-0035**. ☺ Also versions RM87. sensitive

Interconnection strip ZGGZ80

- designed for the co-operation with plug-in sockets of miniature relays and with interface relays PI84 and PI85, which are equipped with screw terminals; sockets and relays are mounted on 35 mm rail mount acc. to PN-EN 60715,
- bridges common input signals (coil terminals A1 or A2) or output signals - see photo at the top,
- maximum permissible current is 10 A / 250 V AC,
- possibility of connection of 8 sockets or relays,
- colours of strips: **ZGGZ80-1** grey, **ZGGZ80-2** black.

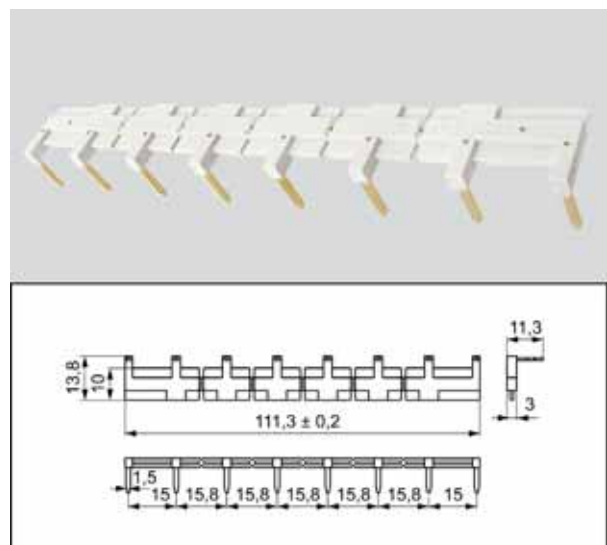

11.05.2013